



Combined displacement and inclination sensor with measurement ranges up to 4,000 mm /  $\pm 180^\circ$



- Protection class up to IP67/IP69
- Robust stainless steel measurement tape
- Multiple deflections possible
- With magnetic absolute encoder
- With inclination sensor in MEMS technology
- Redundant version available

### Product version



Digital output CANopen

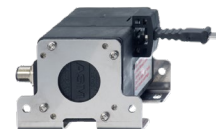

WBT61 - Combined displacement and inclination sensor  
Version with digital output CANopen

Specifications

		Order options
Measurement range (position)	1500 / 2000 / 2500 / 3000 / 3500 / 4000 mm	<b>1</b> 1500 / 2000 / 2500 / 3000 / 3500 / 4000
Measurement range (inclination)	±180° with 1 axis	
Inclination axis	Inclination in X axis ≤±180°	
Resolution	setting via CAN-Bus	
Output	Digital output CANopen Digital output CANopen, redundant	<b>2</b> MCANOP MCANOPR
Linearity of position measurement	±0.10% f.s. (standard) ±0.05% f.s. (optional)	<b>3</b> L10 L05
Linearity of inclination measurement	0.05° (±30°) 0.1° (±60°) 0.2° (±180°)	
Sensing device (position measurement)	Magnetic absolute encoder	
Sensing device (inclination measurement)	MEMS device	
Material	PBT, stainless steel Tape: stainless steel, 10 mm wide, 0,08 mm thick	
Protection class	IP67/IP69	
Connection	Connector M12, 5 pin	<b>4</b> M12/CAN
Dust wiper		<b>5</b> BAB1
Shock	DIN EN 60068-2-27:1993, 100 g/11 ms, 100 shocks	
Vibration	EN 60068-2-6:2008, 20 g 10 Hz-2 kHz, 10 cycles	
Temperature range	-40 ... +85°C	
Weight	approx. 600 g with mounting brackets (140 g)	
EMC	DIN EN 61326-1:2013	

Order code

WBT61 – **1** – **2** – **3** – **4** – **5**

Order example: WBT61 – 4000 – MCANOP – L10 – M12/CAN – BAB1

Dimensions

WBT61

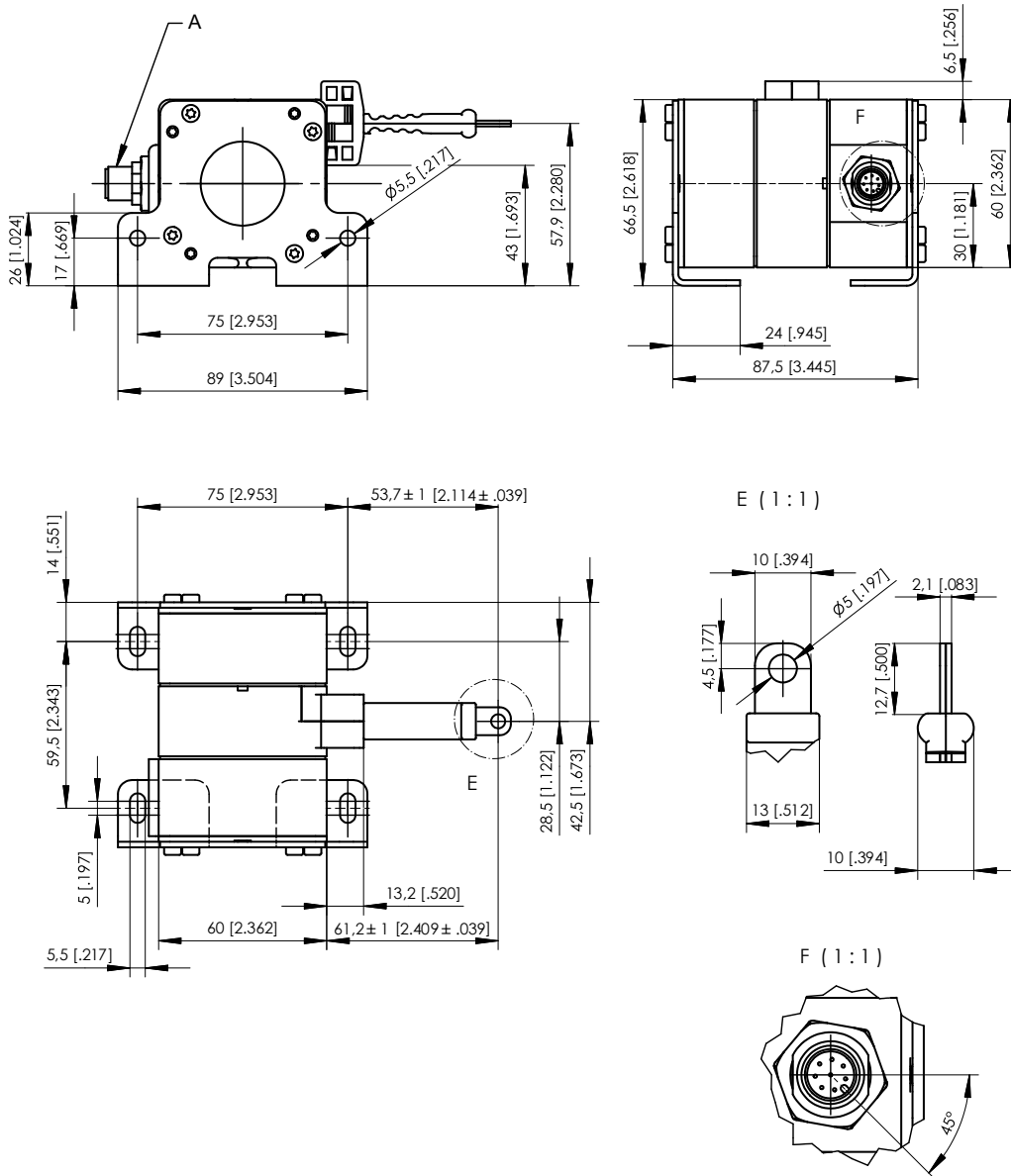

A – Connector M12

Dimensions in mm [inch]

Dimensions informative only.

For guaranteed dimensions consult factory.

**Mounting options for inclination measurement for WBT61 / WBT85 sensors**

The mounting option can be set by the user via software. Sensor position as shown equals 0°.

**WBT61 / WBT85**

**Mounting option 1**

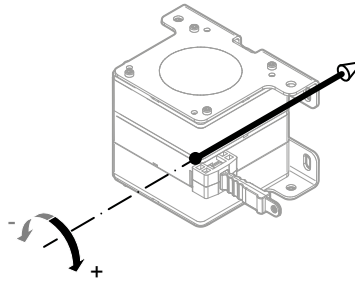

**Mounting option 2**

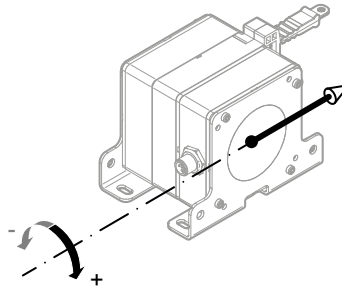

**Mounting option 3**

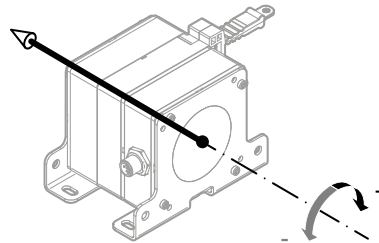

**Output signal**

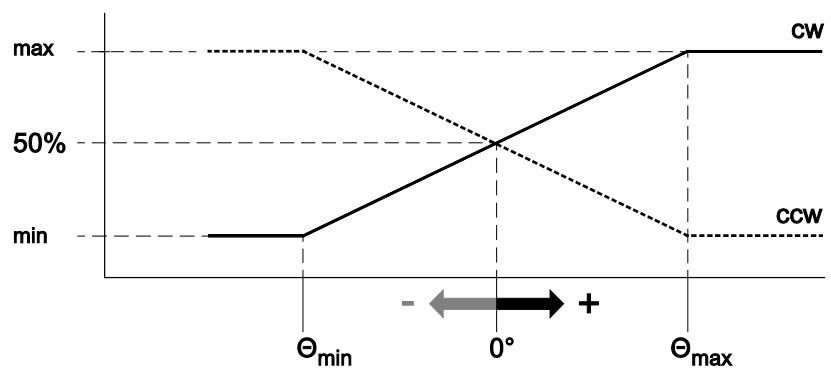

## Interface CANopen

<b>MCANOP, CANOPR</b>		
	CAN specification	ISO 11898, Basic and Full CAN 2.0 B
	Communication profile	CANopen CiA 301 V 4.02, Slave
	Encoder profile	Encoder CiA 406 V 3.2
	Error Control	Node Guarding, Heartbeat, Emergency Message
	Node ID	Adjustable via LSS or SDO, default: 127
	PDO	3 TxPDO, 0 RxPDO, no linking, static mapping
	PDO Modes	Event-/Time triggered, Remote-request, Sync cyclic/acyclic
	SDO	1 Server, 0 Client
	CAM	8 cams
	Certified	Yes
	Transmission rate	50 kBit bis 1 Mbit, adjustable via LSS or SDO, default: 125 kBit
	Bus connection	M12 connector, 5 pin
	Integrated bus terminating resistor	120Ω adjustable by the customer
	Bus, galvanic isolated	no

<b>Specifications</b>		
Excitation voltage	8 ... 36 V DC	
Excitation current	20 mA typical at 24 V DC 40 mA typical at 12 V DC 80 mA max.	
Measuring rate	0.5 kHz	
Stability (temperature)	±50 x 10 <sup>-6</sup> /°C f.s. (typical)	
Repeatability	1 LSB	
Operating temperature	See specification of the respective sensor	
Protection	Reverse polarity, short circuit	
Dielectric strength	1 kV (V AC, 50 Hz, 1 min.)	
EMC	EN 61326-1:2013	

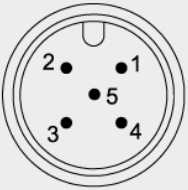
<b>Signal wiring</b>	<b>Output signals</b>	<b>Connector pin no.</b>
<b>Connector M12, 5 pin</b>  View to the sensor connector	Shield	1
	Excitation +	2
	GND	3
	CAN-H	4
	CAN-L	5

## Accessories

### Connector/bus cable M12, 5 pin CAN-Bus

The 5-lead shielded cable is supplied with a female 5 pin M12 connector at one end and a male 5 pin M12 connector at the other end.

Available lengths are 0.3 m, 2 m, 5 and 10 m.

Cable diameter: 6.7 ±0.2 mm

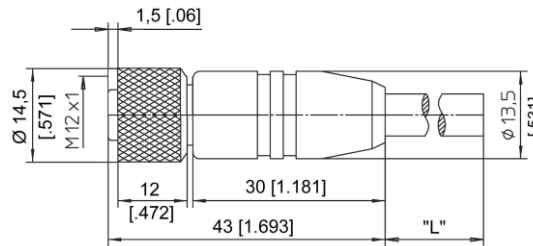

#### Order code

**KAB - xM - M12/5F/G - M12/5M/G - CAN**

IP69: **KAB - xM - M12/5F/G/69K - M12/5M/G/69K - CAN**

xM = length in m

### T-connector for bus cable M12, 5 pin CAN-Bus

#### Order code

**KAB - TCONN - M12/5M - 2M12/5F - CAN**



### Terminating resistor M12, 5 pin CAN-Bus

#### Order code

**KAB - RTERM - M12/5M/G - CAN**



#### Applicable for cable carriers

Maximum movement speed	3 m/s
Maximum acceleration	5 m/s <sup>2</sup>
Minimum bending radius	10 x cable diameter

## Tape pulley WBR1

Order code: WBR1

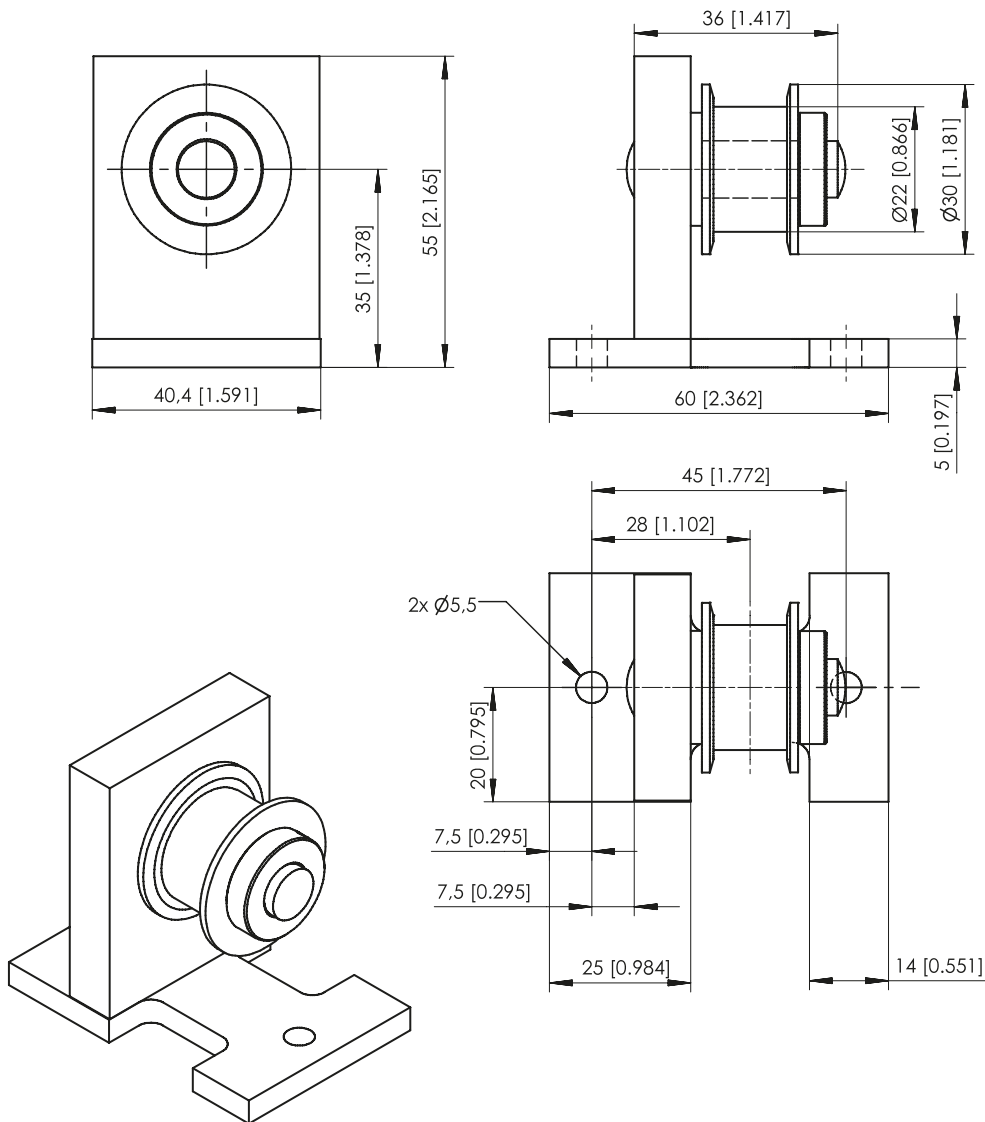

Dimensions in mm [inch]  
Dimensions informative only.  
For guaranteed dimensions consult factory.