

 **WB12**

Displacement sensor with
measurement length
up to 4,000 mm



- Protection class up to IP67/IP69
- Robust stainless steel measurement tape
- Multiple deflections possible
- With magnetic absolute encoder
- Redundant version available

Product versions



Analog output



Analog output, programmable



Analog output, redundant



Digital output SSI



Digital output CANopen, SAE J1939



WB12 - Tape Extension Position Sensor Version with analog output

Specifications

		Order options
Measurement range	250 / 375 / 500 / 750 / 1000 / 1250 / 1500 / 2000 / 2500 / 3000 / 3500 / 4000 mm	1 250 / 375 / 500 / 750 / 1000 / 1250 / 1500 / 2000 / 2500 / 3000 / 3500 / 4000
Resolution	<0.05 mm	
Output	Voltage 0.5 ... 10 V Voltage 0.5 ... 4.5 V Current 4 ... 20 mA, 3 wire	2 U2 U8 I1
Signal characteristics	Increasing (eg. 4 ... 20 mA) Decreasing (eg. 20 ... 4 mA)	3 A D
Linearity	±0.10% f.s. (standard) ±0.05% f.s. (optional, only for measurement ranges ≥1000 mm)	4 L10 L05
Sensing device	Magnetic absolute encoder	
Material	Aluminum, TPU Tape: stainless steel, 10 mm wide, 0,08 mm thick	
Protection class	IP67/IP69 (with mating connector only)	
Connection	Connector M12, 5 pin	5 M12A5
Dust wiper		6 BAB1
Shock	DIN EN 60068-2-27:1993, 100 g/11 ms, 100 shocks	
Vibration	DIN EN 60068-2-6:2008, 20 g 10 Hz-2 kHz, 10 cycles	
Temperature range	-40 ... +85°C	
Weight	max. 3 kg	
EMC	DIN EN 61326-1:2013	

Order code

WB12	-	1	-	2	-	3	-	4	-	5	-	6
------	---	----------	---	----------	---	----------	---	----------	---	----------	---	----------

Order example: WB12 – 4000 – U2 – A – L10 – M12A5 – BAB1

Accessories:

Connector cable (see page 19)



WB12 - Tape Extension Position Sensor
Version with analog output, programmable

Specifications

		Order options
Measurement range	250 / 375 / 500 / 750 / 1000 / 1250 / 1500 / 2000 / 2500 / 3000 / 3500 / 4000 mm	1 250 / 375 / 500 / 750 / 1000 / 1250 / 1500 / 2000 / 2500 / 3000 / 3500 / 4000
Resolution	<0.05 mm	
Output	Voltage 0.5 ... 10 V, programmable Voltage 0.5 ... 4.5 V, programmable Current 4 ... 20 mA, 3 wire, programmable	2 U2/PMU U8/PMU I1/PMU
Signal characteristics	Increasing (eg. 4 ... 20 mA) Decreasing (eg. 20 ... 4 mA)	3 A D
Linearity	±0.10% f.s. (standard) ±0.05% f.s. (optional, only for measurement ranges ≥1000 mm)	4 L10 L05
Sensing device	Magnetic absolute encoder	
Material	Aluminum, TPU Tape: stainless steel, 10 mm wide, 0,08 mm thick	
Protection class	IP67/IP69 (with mating connector only)	
Connection	Connector M12, 5 pin	5 M12A5
Dust wiper		6 BAB1
Shock	DIN EN 60068-2-27:1993, 100 g/11 ms, 100 shocks	
Vibration	DIN EN 60068-2-6:2008, 20 g 10 Hz-2 kHz, 10 cycles	
Temperature range	-40 ... +85°C	
Weight	max. 3 kg	
EMC	DIN EN 61326-1:2013	

Order code

WB12	-	1	-	2	-	3	-	4	-	5	-	6
------	---	----------	---	----------	---	----------	---	----------	---	----------	---	----------

Order example: WB12 – 4000 – U2/PMU – A – L10 – M12A5 – BAB1

Accessories:

Connector cable (see page 20)



WB12 - Tape Extension Position Sensor
Version with analog output, redundant

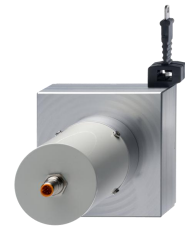

Specifications

		Order options
Measurement range	250 / 375 / 500 / 750 / 1000 / 1250 / 1500 / 2000 / 2500 / 3000 / 3500 / 4000 mm	1 250 / 375 / 500 / 750 / 1000 / 1250 / 1500 / 2000 / 2500 / 3000 / 3500 / 4000
Resolution	<0.05 mm	
Output	Voltage 0.5 ... 10 V, redundant Voltage 0.5 ... 4.5 V, redundant Current 4 ... 20 mA, 3 wire, redundant	2 U2R U8R I1R
Signal characteristics	Output 1 increasing, output 2 increasing Output 1 increasing, output 2 decreasing Output 1 decreasing, output 2 decreasing	3 A/A A/D D/D
Linearity	±0.10% f.s. (standard) ±0.05% f.s. (optional, only for measurement ranges ≥1000 mm)	4 L10 L05
Sensing device	Magnetic absolute encoder	
Material	Aluminum, TPU Tape: stainless steel, 10 mm wide, 0,08 mm thick	
Protection class	IP67/IP69 (with mating connector only)	
Connection	Connector M12, 8 pin	5 M12A8
Dust wiper		6 BAB1
Shock	DIN EN 60068-2-27:1993, 100 g/11 ms, 100 shocks	
Vibration	DIN EN 60068-2-6:2008, 20 g 10 Hz-2 kHz, 10 cycles	
Temperature range	-40 ... +85°C	
Weight	max. 3 kg	
EMC	DIN EN 61326-1:2013	

Order code

WB12	-	1	-	2	-	3	-	4	-	5	-	6
------	---	----------	---	----------	---	----------	---	----------	---	----------	---	----------

Order example: WB12 – 4000 – I1R – A/D – L10 – M12A8 – BAB1

Accessories:

Connector cable (see page 21)



WB12 - Tape Extension Position Sensor
Version with digital output SSI

Specifications

			Order options
Measurement range	250 / 375 / 500 / 750 / 1000 / 1250 / 1500 / 2000 / 2500 / 3000 / 3500 / 4000 mm	1	250 / 375 / 500 / 750 / 1000 / 1250 / 1500 / 2000 / 2500 / 3000 / 3500 / 4000
Resolution	10 µm, 50 µm, 100 µm	2	100
Output	Digital output SSI	3	MSSI
Linearity	±0.10% f.s. (standard) ±0.05% f.s. (optional, only for measurement ranges ≥1000 mm)	4	L10 L05
Sensing device	Magnetic absolute encoder		
Material	Aluminum, TPU Tape: stainless steel, 10 mm wide, 0,08 mm thick		
Protection class	IP67/IP69 (with mating connector only)		
Connection	Connector M12, 8 pin	5	M12A8
Dust wiper		6	BAB1
Shock	DIN EN 60068-2-27:1993, 100 g/11 ms, 100 shocks		
Vibration	DIN EN 60068-2-6:2008, 20 g 10 Hz-2 kHz, 10 cycles		
Temperature range	-40 ... +85°C		
Weight	max. 3 kg		
EMC	DIN EN 61326-1:2013		

Order code

WB12 – **1** – **2** – **3** – **4** – **5** – **6**

Order example: WB12 – 4000 – 100 – MSSI – L10 – M12A8 – BAB1

Accessories:

Connector cable (see page 21)



WB12 - Tape Extension Position Sensor
Version with digital output CANopen, SAE J1939

Specifications

		Order options
Measurement range	250 / 375 / 500 / 750 / 1000 / 1250 / 1500 / 2000 / 2500 / 3000 / 3500 / 4000 mm	1 250 / 375 / 500 / 750 / 1000 / 1250 / 1500 / 2000 / 2500 / 3000 / 3500 / 4000
Resolution	Setting via CAN Bus	
Output	CANopen SAE J1939	2 MCANOP MCANJ1939
Linearity	±0.10% f.s. (standard) ±0.05% f.s. (optional, only for measurement ranges ≥1000 mm)	3 L10 L05
Sensing device	Magnetic absolute encoder	
Material	Aluminum, TPU Tape: stainless steel, 10 mm wide, 0,08 mm thick	
Protection class	IP67/IP69 (with mating connector only)	
Connection	Connector M12, 5 pin	4 M12/CAN
Dust wiper		5 BAB1
Shock	DIN EN 60068-2-27:1993, 100 g/11 ms, 100 shocks	
Vibration	DIN EN 60068-2-6:2008, 20 g 10 Hz-2 kHz, 10 cycles	
Temperature range	-40 ... +85°C	
Weight	max. 3 kg	
EMC	DIN EN 61326-1:2013	

Order code

WB12	-	1	-	2	-	3	-	4	-	5
------	---	----------	---	----------	---	----------	---	----------	---	----------

Order example: WB12 – 4000 – MCANJ1939 – L10 – M12/CAN – BAB1

Accessories:

Connector cable (see page 22)

Dimensions

WB12 up to 2000 mm

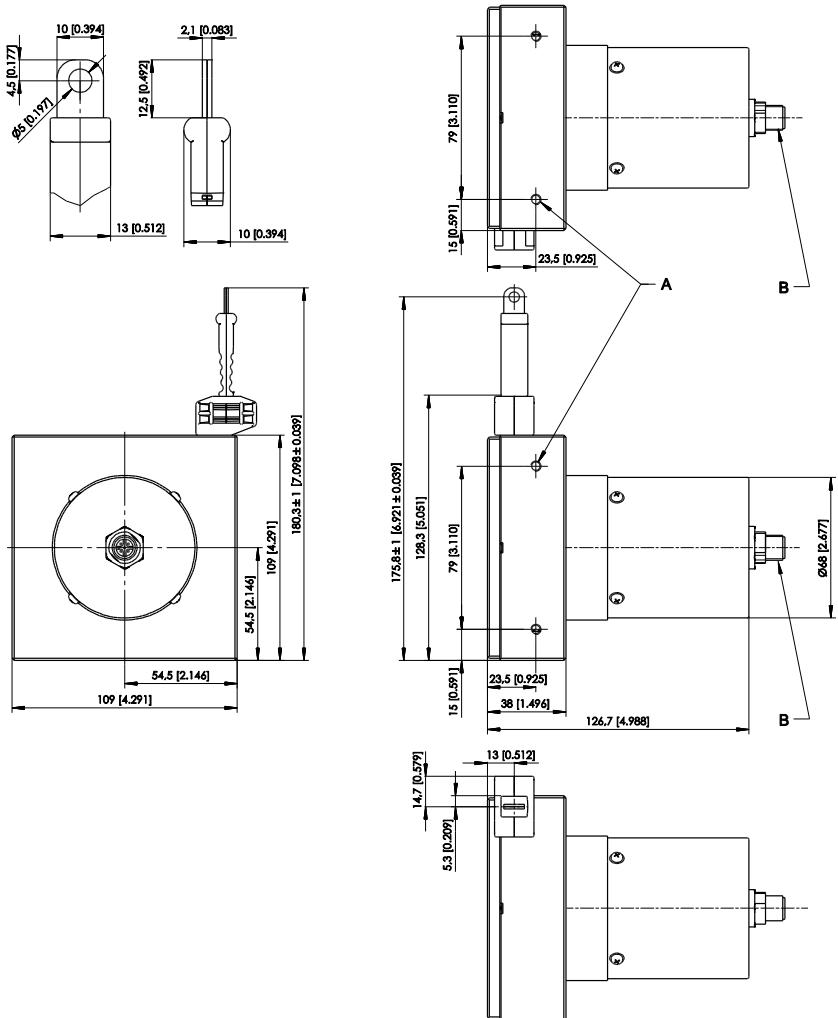

Measurement range	Dimension A
250, 375, 500, 750, 1000	25.5
1250, 1500, 2000	9.5

B – 4 x M5-8 [.315] deep
C – Connector M12

Dimensions in mm [inch].
Dimensions informative only.
For guaranteed dimensions consult factory.

WB12 2500 mm up to 4000 mm

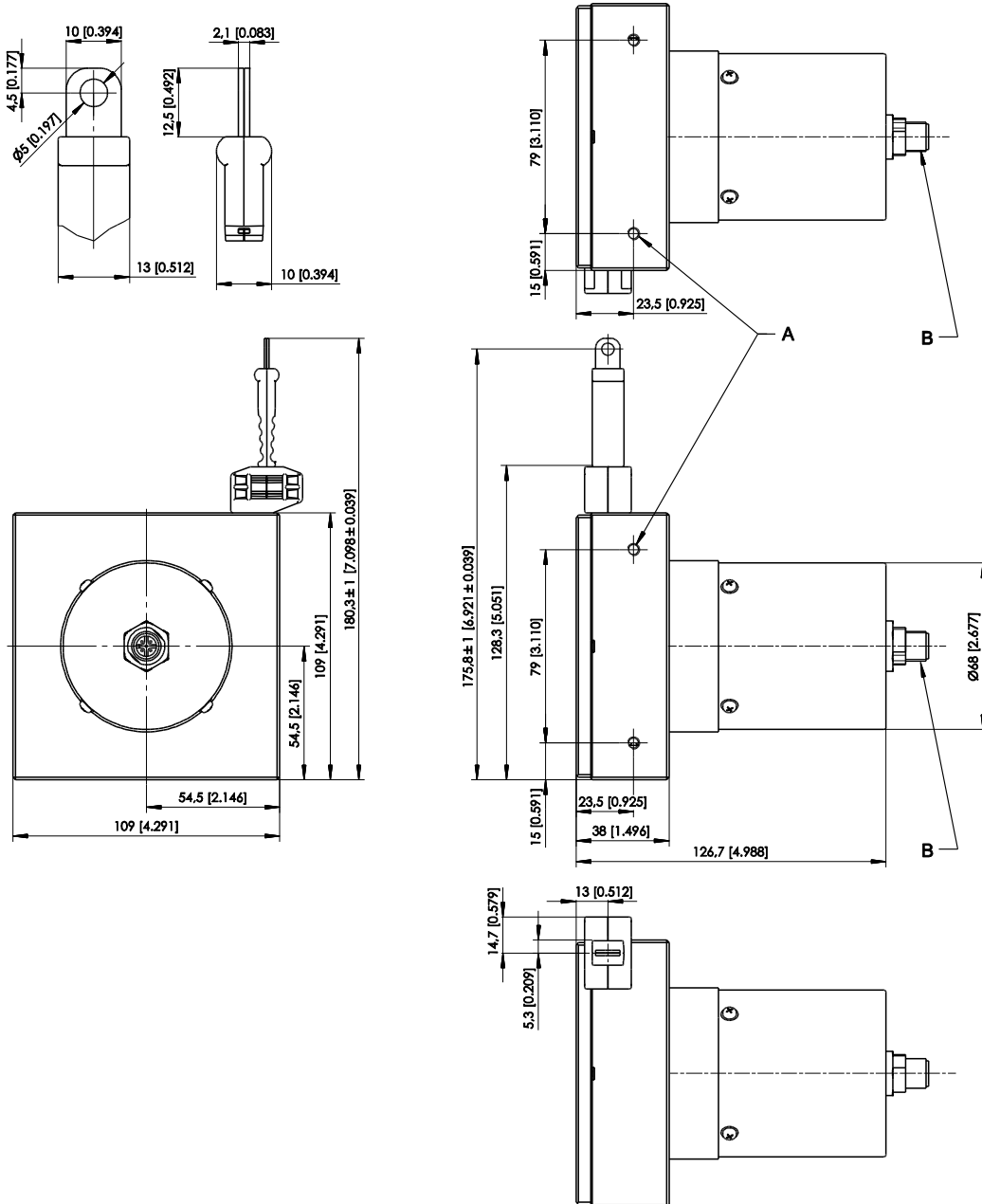



A – 4 x M5-8 [.315] deep
B – Connector M12

Dimensions in mm [inch]
Dimensions informative only.
For guaranteed dimensions consult factory.

Output specification

Analog output

U2 Voltage output 0.5 ... 10 V 	Excitation voltage	8 ... 36 V DC
	Excitation current	20 mA typical at 24 V DC 38 mA typical at 12 V DC max. 50 mA
	Output voltage	0.5 ... 10 V DC
	Output current	2 mA max.
	Measuring rate	1 kHz standard
	Stability (temperature)	$\pm 50 \times 10^{-6}$ / °C f.s. (typical)
	Protection	Reverse polarity, short circuit
	Operating temperature	See specification of the respective sensor
	EMC	DIN EN 61326-1:2013

U8 Voltage output 0.5 ... 4.5 V 	Excitation voltage	8 ... 36 V DC
	Excitation current	17 mA typical at 24 V DC 32 mA typical at 12 V DC 50 mA max.
	Output voltage	0.5 ... 4.5 V DC
	Output current	2 mA max.
	Measuring rate	1 kHz standard
	Stability (temperature)	$\pm 50 \times 10^{-6}$ / °C f.s. (typical)
	Protection	Reverse polarity, short circuit
	Operating temperature	See specification of the respective sensor
	EMC	DIN EN 61326-1:2013

I1 Current output 4 ... 20 mA, 3 wires 	Excitation voltage	8 ... 36 V DC
	Excitation current	typical 36 mA at 24 V DC typical 70 mA at 12 V DC 120 mA max.
	Load R _L	500 Ω max.
	Output current	4 ... 20 mA
	Measuring rate	1 kHz standard
	Stability (temperature)	$\pm 50 \times 10^{-6}$ / °C f.s. (typical)
	Protection	Reverse polarity, short circuit
	Operating temperature	See specification of the respective sensor
	EMC	DIN EN 61326-1:2013

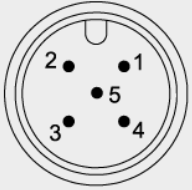
Signal wiring	Output signals	Connector pin no.	Cable color
Connector M12, 5 pin  View to the sensor connector	Excitation +	1	brown
	Signal	2	white
	GND	3	blue
	Do not connect!	4	black
	Do not connect!	5	(grey)

Analog output, programmable

U2/PMU Voltage output 0.5 ... 10 V 	Excitation voltage	8 ... 36 V DC
	Excitation current	20 mA typical at 24 V DC 38 mA typical at 12 V DC max. 50 mA
	Output voltage	0,5 ... 10 V DC
	Output current	2 mA max.
	Measuring rate	1 kHz standard
	Stability (temperature)	$\pm 50 \times 10^{-6}$ / °C f.s. (typical)
	Protection	Reverse polarity, short circuit
	Operating temperature	See specification of the respective sensor
	EMC	EN 61326-1:2013

U8/PMU Voltage output 0.5 ... 4.5 V 	Excitation voltage	8 ... 36 V DC
	Excitation current	17 mA typical at 24 V DC 32 mA typical at 12 V DC max. 50 mA
	Output voltage	0.5 ... 4.5 V DC
	Output current	2 mA max.
	Measuring rate	1 kHz standard
	Stabilität (Temperatur)	$\pm 50 \times 10^{-6}$ / °C f.s. (typical)
	Protection	Reverse polarity, short circuit
	Operating temperature	See specification of the respective sensor
	EMC	DIN EN 61326-1:2013

I1/PMU Current output 4 ... 20 mA, 3 wires 	Excitation voltage	8 ... 36 V DC
	Excitation current	typical 36 mA at 24 V DC typical 70 mA at 12 V DC max. 120 mA
	Load R_L	500 Ω max.
	Output current	4 ... 20 mA
	Measuring rate	1 kHz standard
	Stability (temperature)	$\pm 50 \times 10^{-6}$ / °C f.s. (typical)
	Protection	Reverse polarity, short circuit
	Operating temperature	See specification of the respective sensor
	EMC	DIN EN 61326-1:2013

Output .../PMU

Programming of the start and end value by the customer (programmable)

Teach-In of start and end value for the analog outputs U2/PMU, U8/PMU, I1/PMU is provided by a binary signal SPAN/ZERO. At the start position connect signal SPAN/ZERO for a period of 2 ... 3 seconds to GND via push button. At the end position connect signal SPAN/ZERO for a period of 5 ... 6 seconds to GND via a push button. The scaling range will be stored non-volatile.

To reset the sensor to factory default ZERO/END must be connected to ground while powering up the sensor for 2 ... 3 seconds.

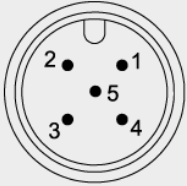
Signal wiring	Output signals	Connector pin no.	Cable color
Connector M12, 5 pin  View to the sensor connector	Excitation +	1	brown
	Signal	2	white
	GND	3	blue
	Do not connect!	4	black
	SPAN/ZERO	5	grey

Analog output, redundant

U2R Voltage output 0.5 ... 10 V 	Excitation voltage	8 ... 36 V DC
	Excitation current	20 mA typical at 24 V DC 38 mA typical at 12 V DC max. 50 mA per channel
	Output voltage	0.5 ... 10 V DC
	Output current	2 mA max.
	Measuring rate	1 kHz standard
	Stability (temperature)	$\pm 50 \times 10^{-6}$ / °C f.s. (typical)
	Protection	Reverse polarity, short circuit
	Operating temperature	See specification of the respective sensor
	EMC	DIN EN 61326-1:2013

U8R Voltage output 0.5 ... 4.5 V 	Excitation voltage	8 ... 36 V DC
	Excitation current	17 mA typical at 24 V DC 32 mA typical at 12 V DC max. 50 mA per channel
	Output voltage	0.5 ... 4.5 V DC
	Output current	2 mA max.
	Measuring rate	1 kHz standard
	Stability (temperature)	$\pm 50 \times 10^{-6}$ / °C f.s. (typical)
	Protection	Reverse polarity, short circuit
	Operating temperature	See specification of the respective sensor
	EMC	DIN EN 61326-1:2013

I1R Current output 4 ... 20 mA, 3 wires 	Excitation voltage	8 ... 36 V DC
	Excitation current	36 mA typical at 24 V DC 76 mA typical at 12 V DC max. 120 mA per channel
	Load R_L	500 Ω max.
	Output current	4 ... 20 mA
	Measuring rate	1 kHz standard
	Stability (temperature)	$\pm 50 \times 10^{-6}$ / °C f.s. (typical)
	Protection	Reverse polarity, short circuit
	Operating temperature	See specification of the respective sensor
	EMC	DIN EN 61326-1:2013

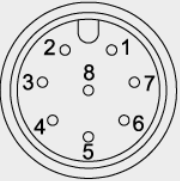
Signal wiring	Channel	Output signals	Connector pin no.	Cable color
Connector M12, 8 pin  View to the sensor connector	1	Excitation +	1	white
		Signal	2	brown
		GND	3	green
		Do not connect!	4	yellow
	2	Excitation +	5	grey
		Signal	6	pink
		GND	7	blue
		Do not connect!	8	red

Digital output

MSSI Synchronous serial SSI 	Interface	EIA RS-422
	Excitation voltage	8 ... 36 V DC
	Excitation current	19 mA typical at 24 V DC 35 mA typical at 12 V DC max. 80 mA
	Clock frequency	100 kHz ... 500 kHz
	Code	Gray-Code, continuous progression
	Delay between pulse trains (t_p)	30 μ s min.
	Stability (temperature)	$\pm 50 \times 10^{-6}$ / °C f.s. (typical)
	Operating temperature	See specification of the respective sensor
	Protection	Reverse polarity, short circuit
	EMC	DIN EN 61326-1:2013

Data format

(Train of 26 pulses)

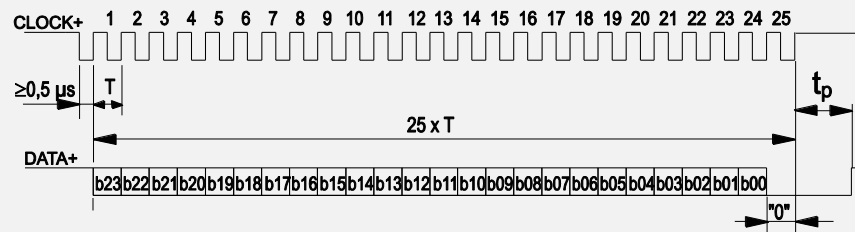

Transmission rate	Cable length	Baud rate	Note:
	50 m	100-400 kHz	Extension of the cable length will reduce the maximum transmission rate.
	100 m	100-300 kHz	

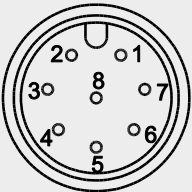
Signal wiring	Output signals	Connector pin no.	Cable color
Connector M12, 8 pin  View to the sensor connector	Excitation +	1	white
	Excitation GND	2	brown
	CLOCK	3	green
	$\overline{\text{CLOCK}}$	4	yellow
	DATA	5	grey
	$\overline{\text{DATA}}$	6	pink
	-	7	blue
	-	8	red

MCANOP, CANOPR CANopen 	CAN specification	ISO 11898, Basic and Full CAN 2.0 B
	Communication profile	CANopen CiA 301 V 4.02, Slave
	Encoder profile	Encoder CiA 406 V 3.2
	Error Control	Node Guarding, Heartbeat, Emergency Message
	Node ID	Adjustable via LSS or SDO, default: 127
	PDO	3 TxPDO, 0 RxPDO, no linking, static mapping
	PDO Modes	Event-/Time triggered, Remote-request, Sync cyclic/acyclic
	SDO	1 Server, 0 Client
	CAM	8 cams
	Certified	Yes
	Transmission rate	50 kBit bis 1 Mbit, adjustable via LSS or SDO, default: 125 kBit
	Bus connection	M12 connector, 5 pin
	Integrated bus terminating resistor	120Ω adjustable by the customer
	Bus, galvanic isolated	no

Specifications	Excitation voltage	8 ... 36 V DC
	Excitation current	20 mA typical at 24 V DC 40 mA typical at 12 V DC 80 mA max.
	Measuring rate	1 kHz (asynchronous)
	Stability (temperature)	±50 x 10 ⁻⁶ /°C f.s. (typical)
	Repeatability	1 LSB
	Operating temperature	See specification of the respective sensor
	Protection	Reverse polarity, short circuit
	Dielectric strength	1 kV (V AC, 50 Hz, 1 min.)
	EMC	EN 61326-1:2013

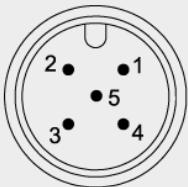
Signal wiring	Output signals	Connector pin no.	Cable color
Connector M12, 5 pin 	Shield	1	brown
	Excitation +	2	white
	GND	3	blue
	CAN-H	4	black
	CAN-L	5	grey

View to the sensor connector

MCANJ1939 SAE J1939 	CAN Specification	ISO 11898, Basic and Full CAN 2.0 B
	Transceiver	24V-compliant, not isolated
	Communication profile	SAE J1939
	Baud Rate	250 kbit/s
	Internal termination resistor	120 Ω adjustable by the customer
	Address	Default 247d, configurable

NAME Fields	Arbitrary address capable	1	Yes
	Industry group	0	Global
	Vehicle system	7Fh (127d)	Non specific
	Vehicle system instance	0	
	Function	FFh (255d)	Non specific
	Function instance	0	
	ECU instance	0	
	Manufacturer	145h (325d)	Manufacturer ID
	Identity number	0nnn	Serial number 21 bit

Parameter Group Numbers (PGN)	Configuration data	PGN EF00h	Proprietary-A (PDU1 peer-to-peer)
	Process data	PGN FFnnh	Proprietary-B (PDU2 broadcast); nn Group Extension (PS) configurable

Specifications	Excitation voltage	8 ... 36 V DC
	Excitation current	20 mA typical at 24 V DC 40 mA typical at 12 V DC max. 80 mA
	Measuring rate	1 kHz (asynchronous)
	Stability (temperature)	±50 x 10 ⁻⁶ /°C f.s. (typical)
	Repeatability	1 LSB
	Operating temperature	See specification of the respective sensor
	Protection	Reverse polarity, short circuit
	Dielectric strength	1 kV (V AC, 50 Hz, 1 min.)
	EMV	EN 61326-1:2013

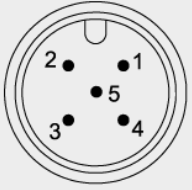
Signal wiring	Output signals	Connector pin no.	Cable color
Connector M12, 5 pin  View to the sensor connector	Shield	1	brown
	Excitation +	2	white
	GND	3	blue
	CAN-H	4	black
	CAN-L	5	grey

Accessories

Connector cable M12, 4 pin (angular coupling)

shielded connector
Suitable for 5-pin
sensor connectors

The 4-core screened cable is supplied with a mating 4-pin 90° M12 connector at one end and 4 wires at the other end. Available lengths are 2 m, 5 m and 10 m.
Wire: cross sectional area 0.34 mm²
Cable diameter: 5.6 ±0.2 mm

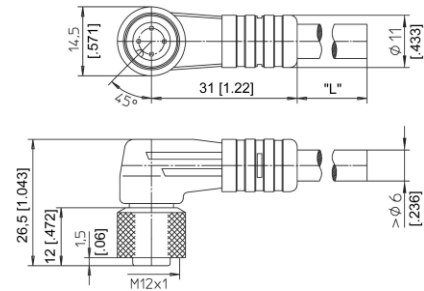

Order code

KAB - xM - M12/4F/W - LITZE

IP69: **KAB - xM - M12/4F/W/69K - LITZE**

xM = length in m

Connector cable M12, 4 pin (straight coupling)

shielded connector
Suitable for 5-pin
sensor connectors

The 4-core screened cable is supplied with a mating 4-pin M12 connector at one end and 4 wires at the other end. Available lengths are 2 m, 5 m and 10 m.
Wire: cross sectional area 0.34 mm²
Cable diameter: 5.6 ±0.2 mm

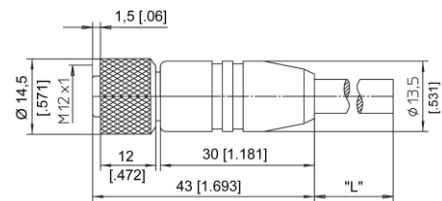

Order code

KAB - xM - M12/4F/G - LITZE

IP69: **KAB - xM - M12/4F/G/69K - LITZE**

xM = length in m

Signal wiring M12, 4 pin	Plug connection / cable color			
	1	2	3	4
	brown	white	blue	black

Applicable for cable carriers

Maximum movement speed	3 m/s
Maximum acceleration	5 m/s ²
Minimum bending radius	10 x cable diameter

Connector cable M12, 5 pin (angular coupling)

shielded connector

The 5-core screened cable is supplied with a mating 5-pin 90° M12 connector at one end and 4 wires at the other end. Available lengths are 2 m, 5 m and 10 m.

Wire: cross sectional area 0.34 mm²

Cable diameter: 5.6 ±0.2 mm

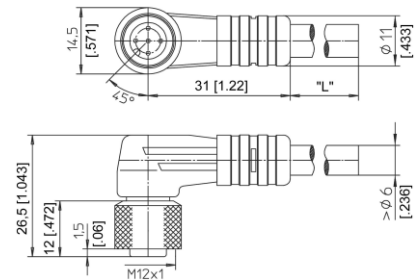

Order code

KAB - xM - M12/5F/W - LITZE

IP69: **KAB - xM - M12/5F/W/69K - LITZE**

xM = length in m

Connector cable M12, 5 pin (straight coupling)

shielded connector

The 5-core screened cable is supplied with a mating 5-pin M12 connector at one end and 4 wires at the other end. Available lengths are 2 m, 5 m and 10 m.

Wire: cross sectional area 0.34 mm²

Cable diameter: 5.6 ±0.2 mm

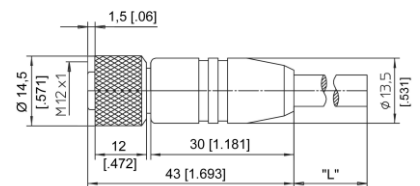

Order code

KAB - xM - M12/5F/G - LITZE

IP69: **KAB - xM - M12/5F/G/69K - LITZE**

xM = length in m

Signal wiring M12, 5 pin	Plug connection / Cable color				
	1	2	3	4	5
	brown	white	blue	black	grey

Applicable for cable carriers

Maximum movement speed	3 m/s
Maximum acceleration	5 m/s ²
Minimum bending radius	10 x cable diameter

Connector cable M12, 8 pin (angular coupling)

shielded connector

The 8-lead shielded cable is supplied with a mating 8-pin 90° M12 connector at one end and 8 wires at the other end. Available lengths are 2 m, 5 m and 10 m. Wire: cross sectional area 0.25 mm²
Cable diameter: 6.3 ±0.2 mm

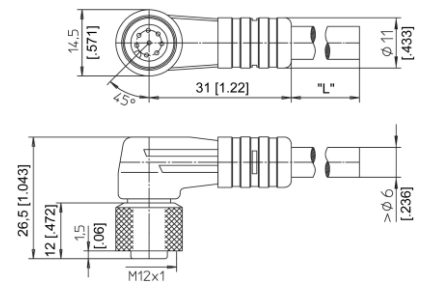

Order code

KAB - xM - M12/8F/W - LITZE

IP69: **KAB - xM - M12/8F/W/69K - LITZE**

xM = length in m

Connector cable M12, 8 pin (straight coupling)

shielded connector

The 8-lead shielded cable is supplied with a mating 8-pin M12 connector at one end and 8 wires at the other end. Available lengths are 2 m, 5 m and 10 m. Wire: cross sectional area 0.25 mm²
Cable diameter: 6.3 ±0.2 mm

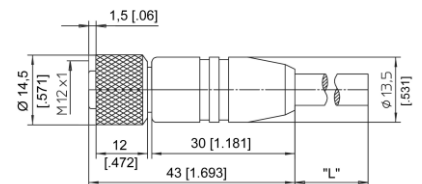

Order code

KAB - xM - M12/8F/G - LITZE

IP69: **KAB - xM - M12/8F/G/69K - LITZE**

xM = length in m

Signal wiring M12, 8 pin	Plug connection / cable color							
	1	2	3	4	5	6	7	8
	white	brown	green	yellow	grey	pink	blue	red

Applicable for cable carriers

Maximum movement speed	3 m/s
Maximum acceleration	5 m/s ²
Minimum bending radius	10 x cable diameter

Connector/bus cable M12, 5 pin CAN-Bus

The 5-lead shielded cable is supplied with a female 5 pin M12 connector at one end and a male 5 pin M12 connector at the other end.

Available lengths are 0.3 m, 2 m, 5 and 10 m.

Cable diameter: 6.7 ±0.2 mm

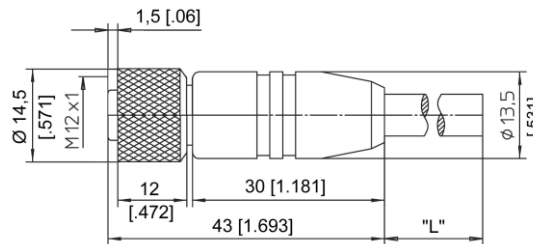

Order code

KAB - xM - M12/5F/G - M12/5M/G - CAN

IP69: **KAB - xM - M12/5F/G/69K - M12/5M/G/69K - CAN**

xM = length in m

T-connector for bus cable M12, 5 pin CAN-Bus

Order code

KAB - TCONN - M12/5M - 2M12/5F - CAN



Terminating resistor M12, 5 pin CAN-Bus

Order code

KAB - RTERM - M12/5M/G - CAN



Applicable for cable carriers

Maximum movement speed	3 m/s
Maximum acceleration	5 m/s ²
Minimum bending radius	10 x cable diameter

Tape pulley WBR1

Order code: WBR1

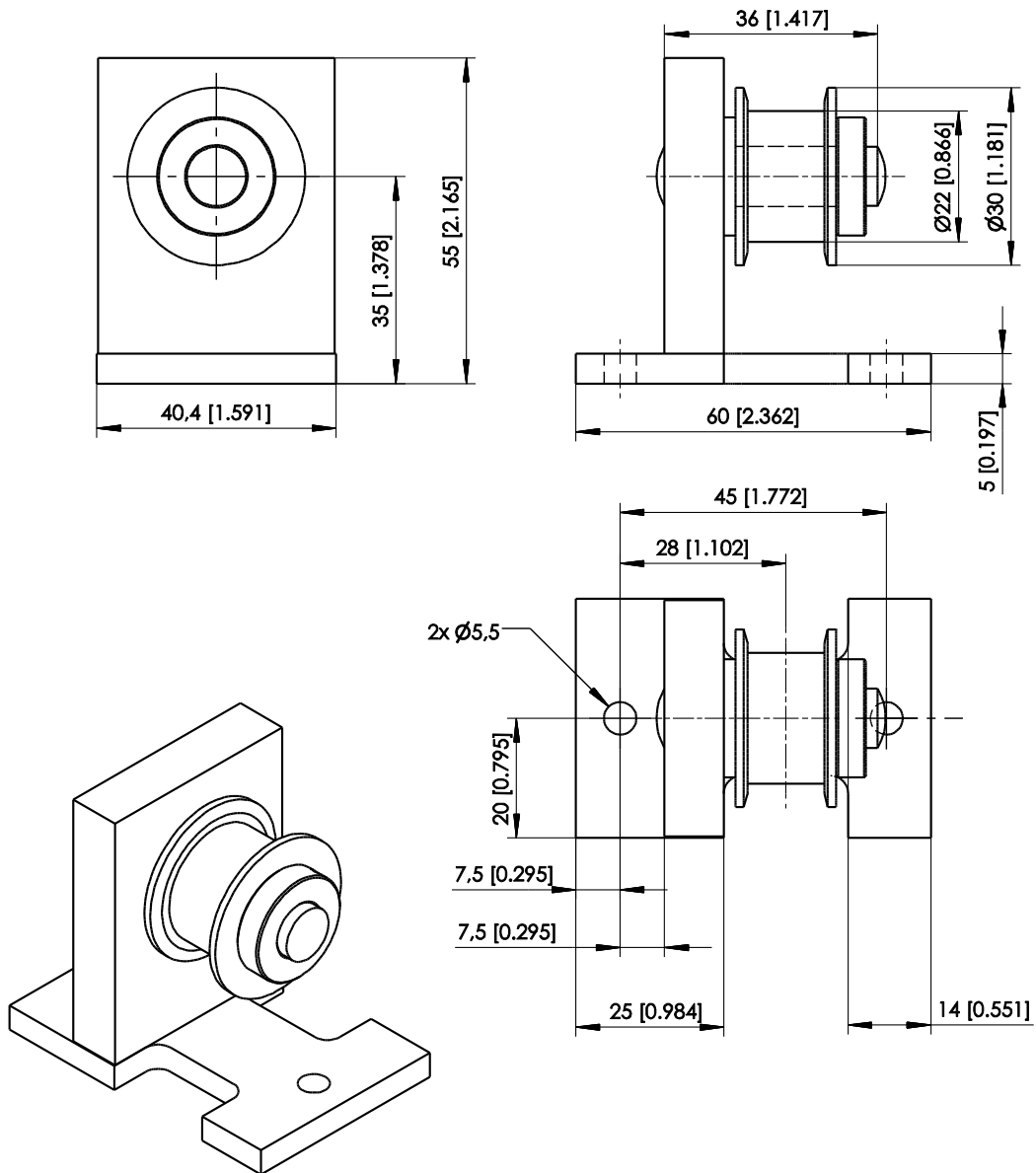

Dimensions in mm [inch]

Dimensions informative only.

For guaranteed dimensions consult factory.