



FEATURES

- Chassis level power terminals – No need for specially routed power cables, special bus bars, or special lugs.
- Rugged **EPIC®** seal rated to 175°C – Reduced risk of fire or meltdown in over current conditions. The same technology used for advanced aerospace programs.
- Hermetically sealed – UL recognized: UL1604 for Class I & II, Div 2 and Class III for use in hazardous locations, IP67 for temporary water immersion for 30 min, IP69K for pressure washing, SAE J1171 - external ignition protection, and ISO8846 for protection against ignition around flammable gasses.
- High Efficiency Dual DC Coils – Very low 12, 24 or 48 VDC continuous coil power with no EMI emissions or cross-talk on your system control power. Ideal for battery powered systems or where low power is needed.
- Built-in coil suppression for all DC coils – Saves you engineering time and parts cost to add external coil suppression.
- Stainless steel nuts and mounting inserts, for years of corrosion free service.
- Not position sensitive – can be mounted in any position for ease of installation.

PRODUCT SPECIFICATIONS

Specifications	Units	Data
Contact Arrangement		
Main	Form X	SPST-NO
Auxiliary (2A, 24VDC) ¹	Form A or B	SPST-NO or SPST-NC
Mechanical Life		
	Cycles	1,000,000
Contact Resistance²		
Max	mohms	0.4
Typical	mohms	0.15 to 0.3
Operate Time³		
Max	ms	20
Typical	ms	13
Release Time, Max		
	ms	12
Insulation Resistance⁴		
	Mohms	100
Dielectric At Sea Level (Leakage < 1mA)		
	VRMS	2,200
Shock, 1/2 Sine, 11ms		
	G peak	20
Vibration, Sinusoidal (500-2000 Hz Peak)		
	G	15
Ambient Temp Range		
Operating ⁵	°C	-55 to +85
Storage	°C	-70 to +150
Weight, Typical		
	Kg (Lb)	0.5 (1.1)
Environmental Seal		
		Exceeds IP67 & IP69K
Salt Fog		
		MIL-STD-810

POWER SWITCHING AND CURRENT CARRY RATINGS

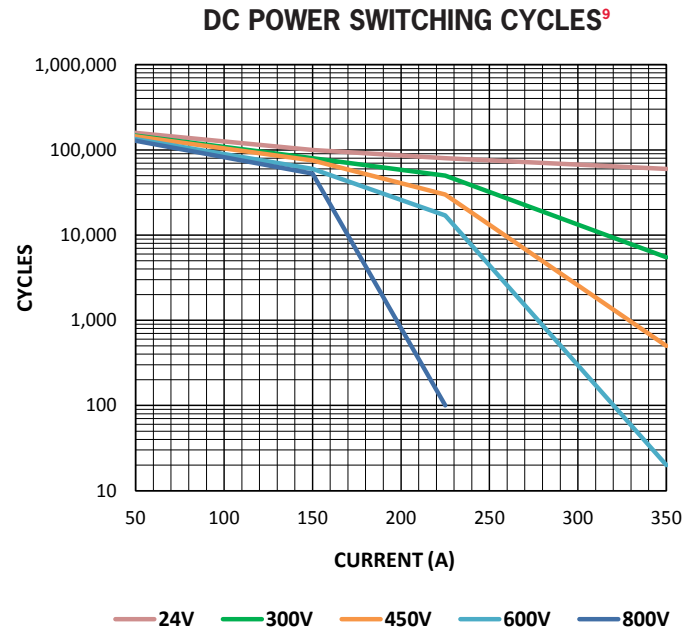

COIL RATINGS at 25°C

Coil P/N Designation	B	C	F
Coil Voltage, Nominal	12 VDC	24 VDC	48 VDC
Coil Voltage, Max	16 V	32 V	64 V
Pick-Up Voltage, Max ^{6, 8}	8 V	16 V	40 V
Drop-Out Voltage	0.5 to 4 V	2 to 7.5 V	4 to 15 V
Pick-Up Current, Max (75 ms) ^{6, 7}	3.9 A	1.6 A	0.97 A
Coil Current ⁷	0.23 A	0.097 A	0.042 A
Coil Power ⁷	2.8 W	2.3 W	2.0 W
Internal Coil Suppression			
Coil Back EMF	55 V	55 V	125 V
Transients, Max (13 ms)	±50 V	±50 V	±75 V
Reverse Polarity	16 V	32 V	64 V

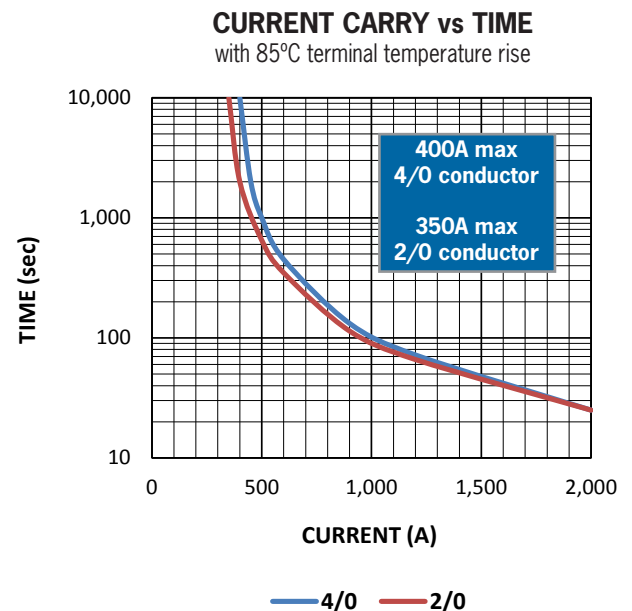

DIMENSIONS

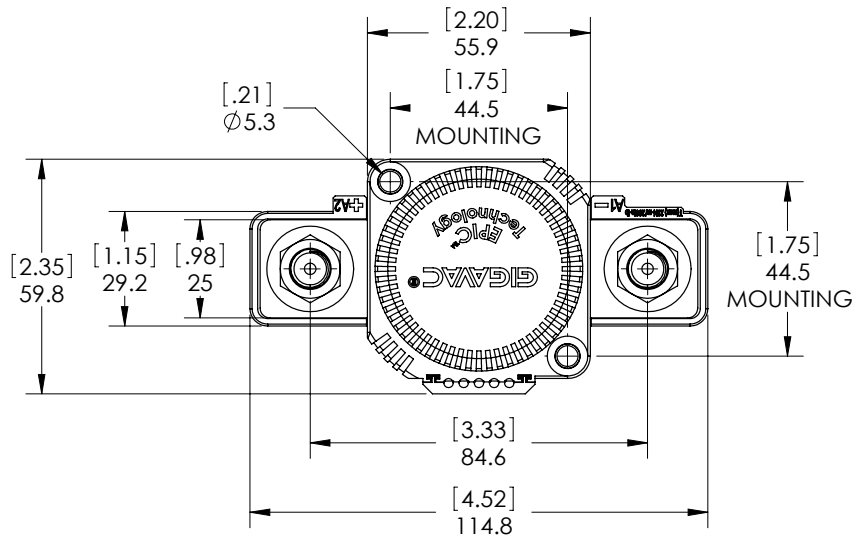
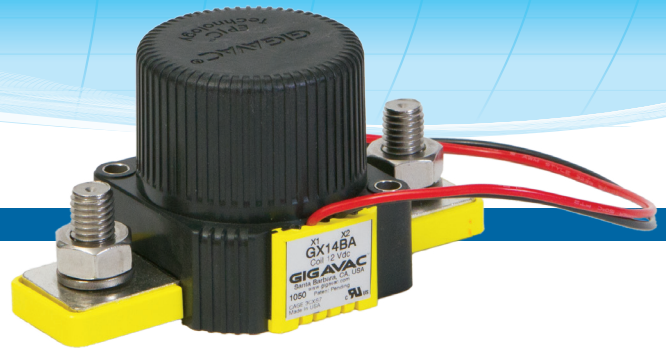

Mounting

M5 Bolts

Case Material

DuPont Zytel FR50
(25% Glass Filled Nylon)

Power Connection

Stainless M10x1.5 Bolt
Stainless M10x1.5 Flanged Nut

Torque 14-20Nm [125-175in-lb]

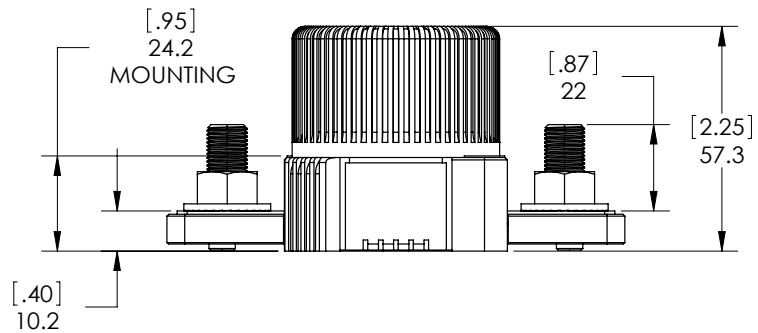

Coil Wire

Silicone, 20 AWG, UL: VW-1

Power Contacts

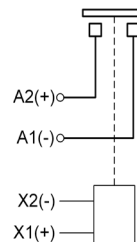

Auxiliary contacts (optional)

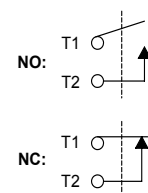

PART NUMBER SYSTEM

GX14	B	A	B
Coil Voltage	B = 12 Vdc, Internal Coil Suppression		
	C = 24 Vdc, Internal Coil Suppression		
	F = 48 Vdc, Internal Coil Suppression		
Coil Termination		A = Flying leads 38 cm (15 in)	
		B = Flying leads 61 cm (24 in)	
		C = Flying leads 122 cm (48 in)	
		D = Coil Terminals, not available with Auxiliary Contacts	
Auxiliary Contact			Blank = None
			B = SPST, Normally Open
			C = SPST, Normally Closed

Notes & Definitions:

- 1 Auxiliary contact rating is 2A, 24Vdc Resistive load, 100,000 cycles. Minimum current is 0.1mA, 5V. The auxiliary contact is mechanically linked to the main power contacts.
- 2 Contact resistance measured at currents higher than 100A.
- 3 Operation time is measured at 25°C and includes maximum 7ms bounce.
- 4 Insulation resistance is 50 Mohms after life.
- 5 Contactor can operate up to 125°C in special cases - contact GIGAVAC for details.
- 6 [Contactor has two coils](#). Both are used for pick-up, and then in approximately 75 milliseconds, one coil is electronically removed from the coil drive circuit. The remaining coil supplies low continuous hold power sufficient for the contactor to meet all of its specified performance specifications. This provides low coil power without PWM electronics that can cause EMI emissions and/or cross-talk on control power.
- 7 Contactor is operated by a coil that changes resistance with temperature. Since Pick-up Current, Coil Current and Coil Power are specified at Nominal Voltage, they will be lower than indicated at temperatures above 25°C and higher than indicated at temperatures below 25°C. Similarly, Pick-up and Drop-out Voltages will be higher than indicated at temperatures above 25°C and lower than indicated at temperatures below 25°C.
- 8 For pick-up testing of contactors with dual coils, the voltage can not be ramped up slowly, but must be applied instantly to at least the maximum Pick-up Voltage. Otherwise, the contactor will not pick-up.
- 9 Limit make current to 600A to avoid contact welding. For AC power switching cycles, contact factory.

APPLICATION NOTES

- Contactors feature internal transorb for coil suppression. [No external diodes](#) should be added across the coil. The use of additional external coil suppression can slow the release time and invalidate the life cycle ratings, or can cause the contactor not to be able to interrupt the maximum current specified. If lower coil back EMF is required, please contact GIGAVAC for assistance.
- Power switching lifecycles are based on [current flow](#) from A2(+) to A1(-). For best breaking performance, the contactor should be installed so that current flows from A2(+) to A1(-). There are cases where the contactor will interrupt power in the opposite direction but please contact GIGAVAC to confirm suitability. Direction of current flow is not relevant during make or when flowing on closed contacts. For bi-directional contactors, please contact GIGAVAC.
- Applications with [capacitors](#) will require a pre-charge circuit.
- Electrical life rating is based on resistive load with 27µH maximum inductance in circuit. Because your application may be different, we suggest you test the contactor in your circuit to verify life is as required.
- End of life is defined as when the dielectric, insulation resistance or contact resistance fails the specifications listed.

Datasheets provided by Sensata Technologies, Inc., its subsidiaries and/or affiliates (“Sensata”) are solely intended to assist third parties (“Buyers”) who are developing systems that incorporate Sensata products (also referred to herein as “components”). Buyer understands and agrees that Buyer remains responsible for using its independent analysis, valuation, and judgment in designing Buyer’s systems and products. Sensata datasheets have been created using standard laboratory conditions and engineering practices. Sensata has not conducted any testing other than that specifically described in the published documentation for a particular datasheet. Sensata may make corrections, enhancements, improvements, and other changes to its datasheets or components without notice.

Buyers are authorized to use Sensata datasheets with the Sensata component(s) identified in each particular datasheet. HOWEVER, NO OTHER LICENSE, EXPRESS OR IMPLIED, BY ESTOPPEL OR OTHERWISE TO ANY OTHER SENSATA INTELLECTUAL PROPERTY RIGHT, AND NO LICENSE TO ANY THIRD PARTY TECHNOLOGY OR INTELLECTUAL PROPERTY RIGHT, IS GRANTED HEREIN. SENSATA DATASHEETS ARE PROVIDED “AS IS”. SENSATA MAKES NO WARRANTIES OR REPRESENTATIONS WITH REGARD TO THE DATASHEETS OR USE OF THE DATASHEETS, EXPRESS, IMPLIED, OR STATUTORY, INCLUDING ACCURACY OR COMPLETENESS. SENSATA DISCLAIMS ANY WARRANTY OF TITLE AND ANY IMPLIED WARRANTIES OF MERCHANTABILITY, FITNESS FOR A PARTICULAR PURPOSE, QUIET ENJOYMENT, QUIET POSSESSION, AND NON-INFRINGEMENT OF ANY THIRD PARTY INTELLECTUAL PROPERTY RIGHTS WITH REGARD TO SENSATA DATASHEETS OR USE THEREOF.

All products are sold subject to Sensata’s terms and conditions of sale supplied at www.sensata.com. SENSATA ASSUMES NO LIABILITY FOR APPLICATIONS ASSISTANCE OR THE DESIGN OF BUYERS’ PRODUCTS. BUYER ACKNOWLEDGES AND AGREES THAT IT IS SOLELY RESPONSIBLE FOR COMPLIANCE WITH ALL LEGAL, REGULATORY, AND SAFETY-RELATED REQUIREMENTS CONCERNING ITS PRODUCTS, AND ANY USE OF SENSATA COMPONENTS IN ITS APPLICATIONS, NOTWITHSTANDING ANY APPLICATIONS-RELATED INFORMATION OR SUPPORT THAT MAY BE PROVIDED BY SENSATA.

Mailing Address: Sensata Technologies, Inc., 529 Pleasant Street, Attleboro, MA 02703, USA

CONTACT US

Regional head offices:

United States of America

Sensata Technologies

Attleboro, MA

Phone: 508-236-3800

E-mail: support@sensata.com

Netherlands

Sensata Technologies Holland B.V.

Hengelo

Phone: +31 74 357 8000

E-mail: support@sensata.com

China

Sensata Technologies China Co., Ltd.

Shanghai

Phone: +8621 2306 1500

E-mail: support@sensata.com

Copyright © 2023 Sensata Technologies, Inc.

Mouser Electronics

Authorized Distributor

Click to View Pricing, Inventory, Delivery & Lifecycle Information:

Sensata:

[GX14FAB](#) [GX14BA](#) [GX14CD](#) [GX14BCC](#) [GX14FCB](#) [GX14CBC](#) [GX14CA](#) [GX14FB](#) [GX14BAC](#) [GX14CCB](#)
[GX14CC](#) [GX14BC](#) [GX14CB](#) [GX14BBB](#) [GX14FBB](#) [GX14CAB](#) [GX14FC](#) [GX14BBC](#) [GX14CAC](#) [GX14BB](#) [GX14FA](#)
[GX14BAB](#) [GX14BD](#) [GX14FCC](#) [GX14FAC](#) [GX14BCB](#) [GX14CBB](#) [GX14CCC](#) [GX14MAB](#)